

Saeclimber Mast Climbing Work Platforms



Winning solutions

SAECLIMBER SL

Mast Climbing Work Platforms

Production range

Model	Climbing Speed (m/min)	Power per Drive Unit (Kw)	Max Height (m)	Twin Mast		Single Mast	
				Payload (Kg)	Max Length (m)	Payload (Kg)	Max Length (m)
P08	6,7	2	50	1000	18,1	500	5,8
P36	7,1	4,4	200	3600	30,1	1500	9,8
P40	7,1	4,4	200	4000	32	1600	12
P40/S	9	7,2	200	6500	32	3300	13
P45	9	6	250	4500	35,5	3000	17,8
P45S	9	10,8	250	8500	37,7	5000	17,8
P50	9	10,8	250	8500	38,2	5500	17,8



P08



P36



P40



P45

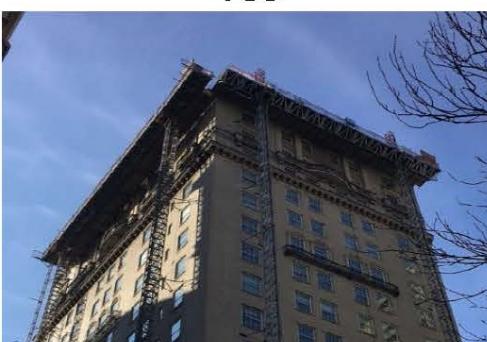

P45/S



P50

SAECLIMBER SL

Saeclimber offers the widest Mast Climbers range



From the small P08

To the huge P50 : 18 m L single mast
and 3 big motors each drive



SAECLIMBER SL



Ideal for Curtain Walling



Perfect for Insulations

SAECLIMBER SL



Single or twin ... Always easy



..... Easy even for big Heights



Glass Curtain walls : all area covered by twins

SAECLIMBER SL



Twin deck single or twin mast available



protection roof available

SAECLIMBER SL



P40 Single mast 14 m Long

SAECLIMBER SL



Roof can be installed for a more comfortable and safe working area

**P45/S and P50 reach 18 m Length in Single mast
Both machines have 3 motors of 4Kw each**



SAECLIMBER SL



Triple mast P40 54 m Long



SAECLIMBER SL

Particular attention is given to special request: Example of Special extensions, FEM calculated, tested and Certified



Nombre del modelo: PT15 - Análisis
Nombre de estudio: Análisis estático 2D (Predeterminado)
Tipo de resultado: Desplazamiento elástico (Desplazamientos)
Escala de deformación: 1/11,200

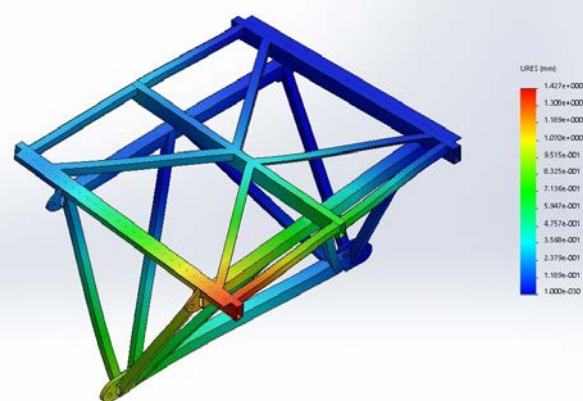
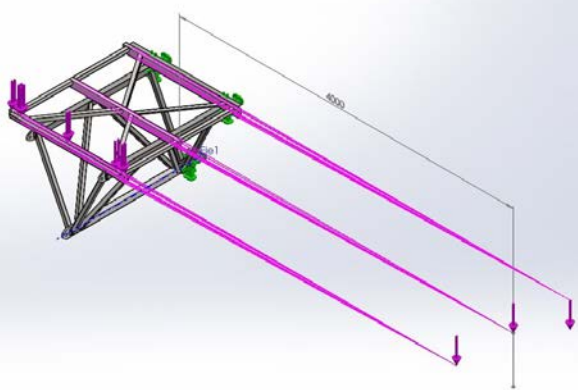

SAECLIMBER SL



High performances in the highway Piles maintenance and renovations. Use of special extensions

SAECLIMBER SL



Sliding roll up extensions for easy balcony works

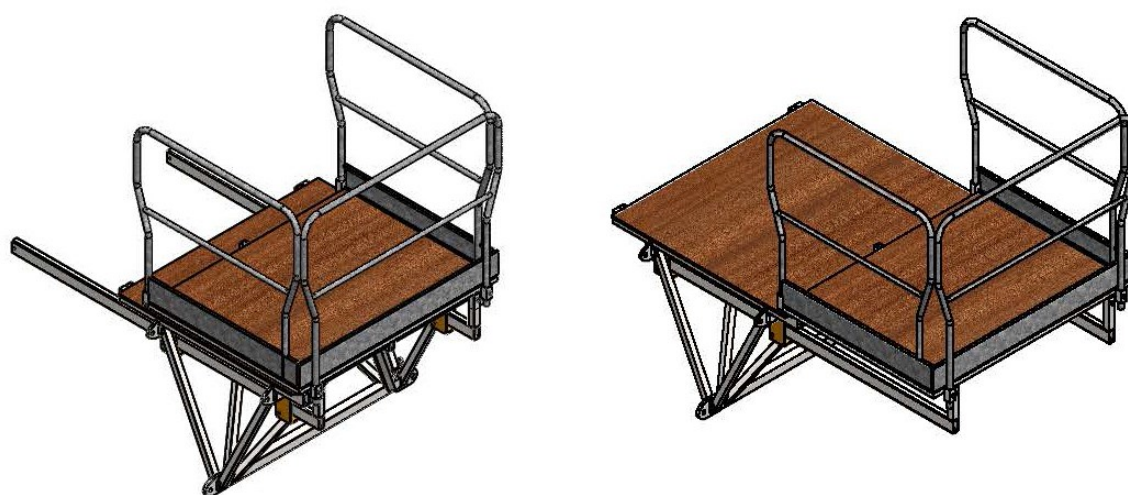

SAECLIMBER SL



Inclination adapting device Facility



Special Inclined MCWP for cooling Towers

SAECLIMBER SL

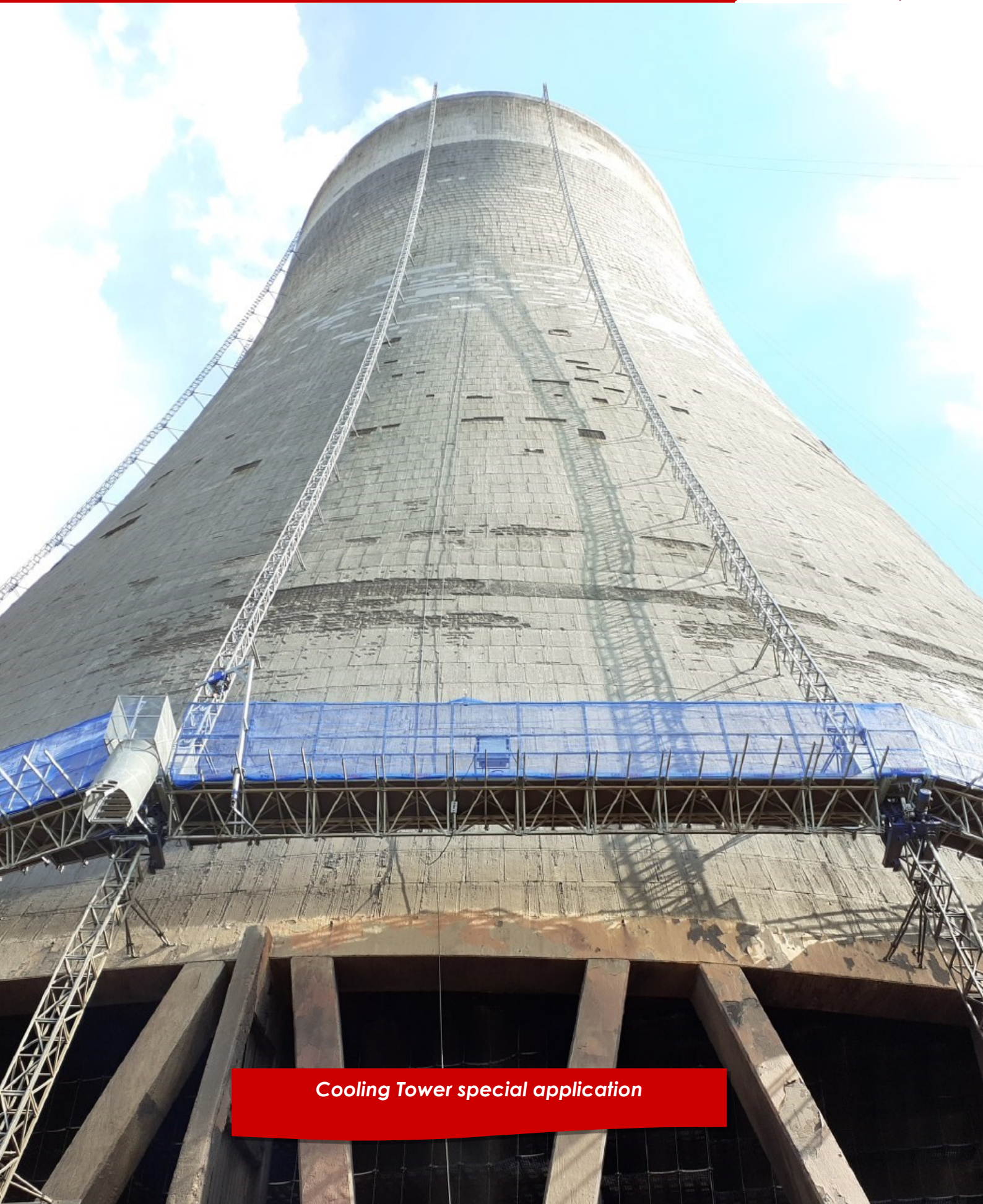

Cooling Tower special application

SAECLIMBER SL



4, 5 or 6 masts synchronized, for chimneys demolition with service hoist



SAECLIMBER SL



5 mast chimney demolition with service hoist



SAECLIMBER SL



**Pluri Mast for highway piles
demolition**



SAECLIMBER SL

**Monorail 500 Kg payload available for
single or twin mast**

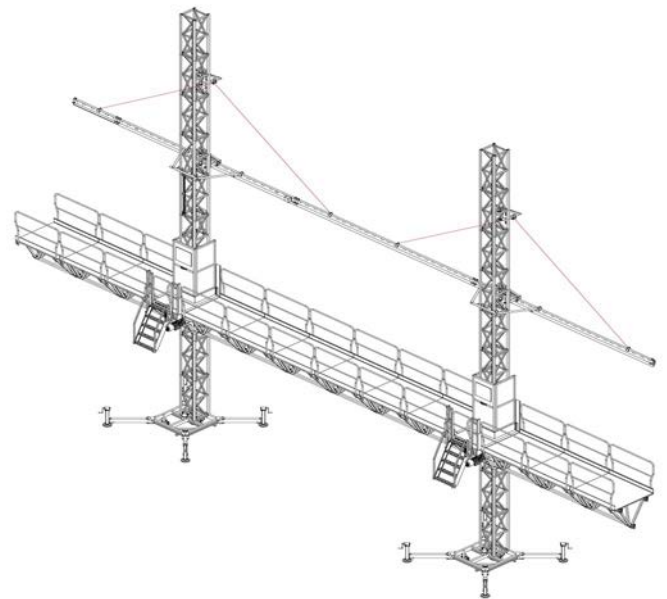
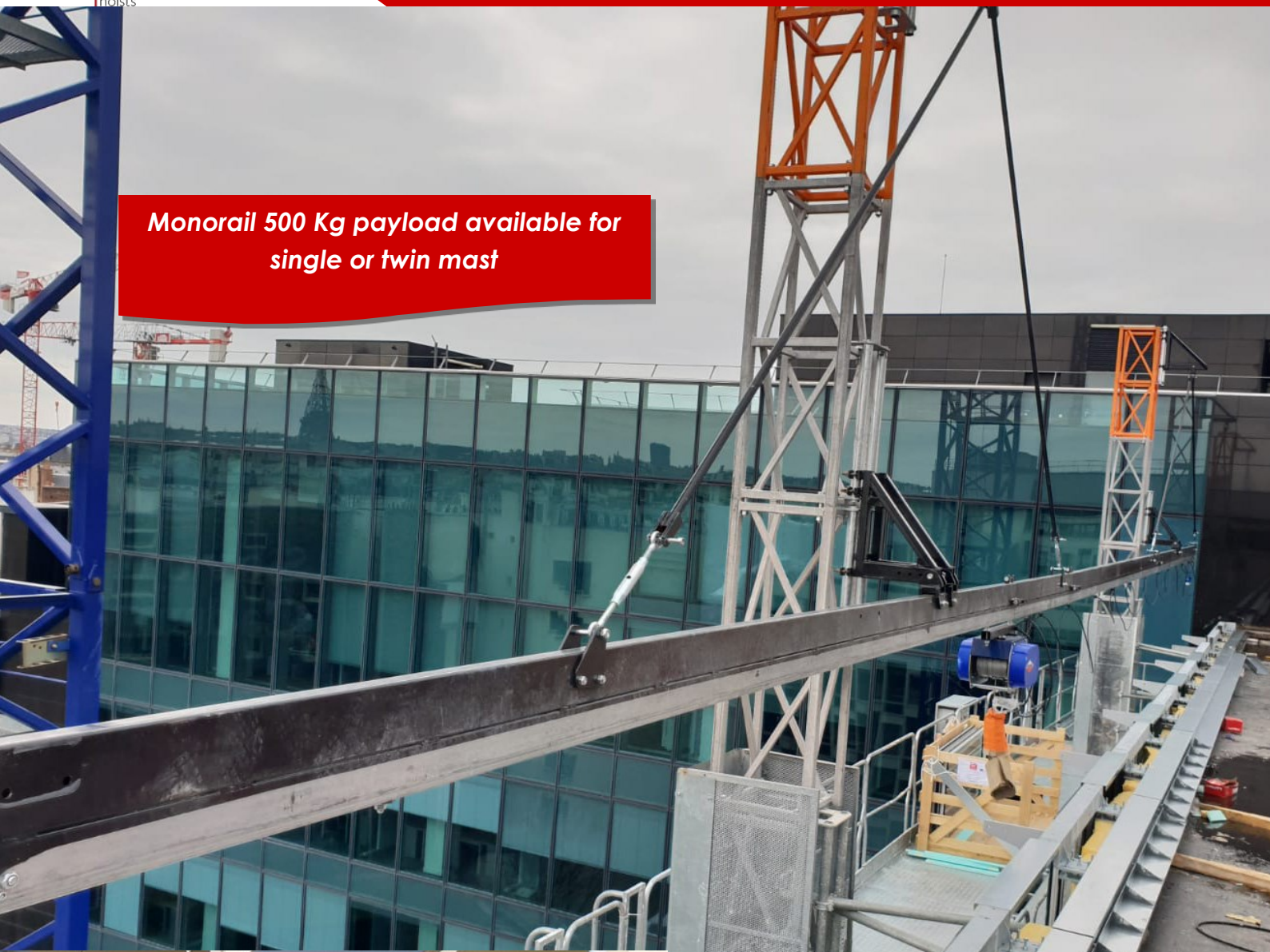

ER-0424/2019

SAECLIMBER SL